

DESCRIPTION

AT series converter / distributor primarily designed for use in the general signal conversion and isolation circuit ; as 4~20mA 、0~10V 、 Thermocouple(Type K, J, E, T) 、Rtd (Pt100Ω) 、Load Cell 、Potentiometer and AC Voltage/Current... 、Complete models 。

This section slim design of the converter / distributor, in addition to providing groups of signal output (Isolation) or 24V excitationsupply for the transmitter the switching power supply willprovide installation convenience. The top and designed power supply, input and output indicators and removable terminal blocks to facilitate on-site construction and working status view.



Slim type

Model	Measurement / Input	Analogue Output	Excitation Output
AT-VA	AC/DC Voltage 0~150V, 0~300V, 0~500V(specify) AC/DC Current 0 ~ 5A, 0~1A(specify), DC 0~50mV, 0~60mV, 0~75mV, 0~100mV	1 OR 2	NA
AT-PR	DC Current 0/4~20mA, Voltage 0/1~5/10V (Choose DP-type , switchable)	1 OR 2	Option 24V/30mA
AT-TR	Rtd temperature Pt100Ω	1 OR 2	NA
AT-TC	Thermo-couple temperature Type K, J, E, T	1 OR 2	NA
AT-SG	Strain Gauge 0~1.0mV/~2.0mV/~3.0mV/~4.0mV per 1 voltage supply	1	10V/30mA
AT-PM	Potential-meter 0~2.0kΩ(3 wire), 2.0kΩ~100.0kΩ(3 wire)	1 OR 2	NA
AT-RS	Resistance 0~200Ω/~200KΩ(2 wire)	1 OR 2	NA

FEATURE

- Output for 0~5V / 0~10V / 1~5V / 2~10V / 4~20mA / 0~20mA changeable by dip switches and terminals
- Dual different signals output available
- LED indications for power, input and output status
- 0.1% accuracy available in option
- 17.5 mm thin profile and 35mm DIN rail mounting
- CE Approved & RoHS

ORDERING INFORMATION

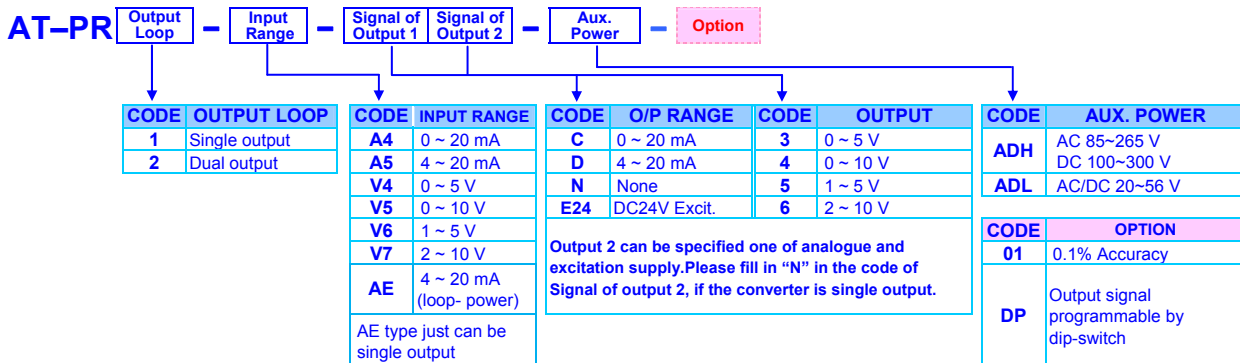
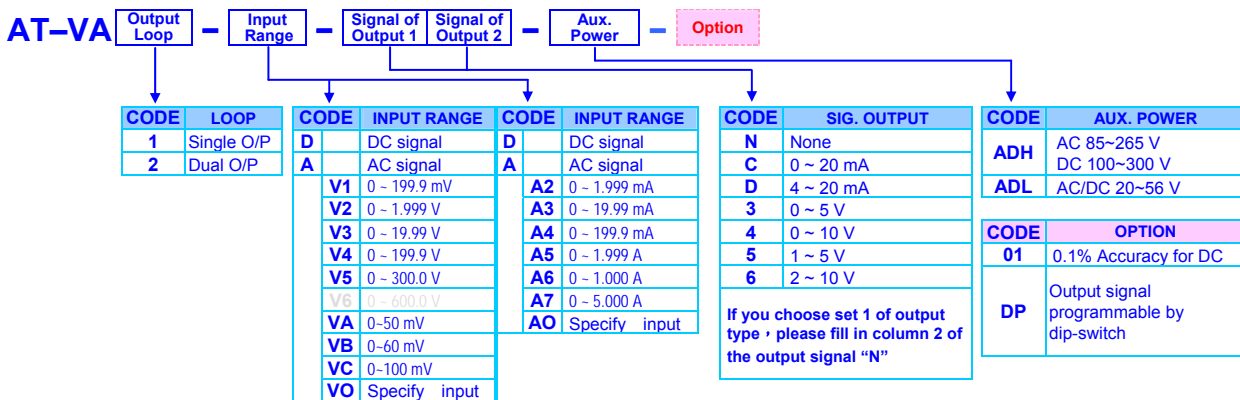

AT-TR

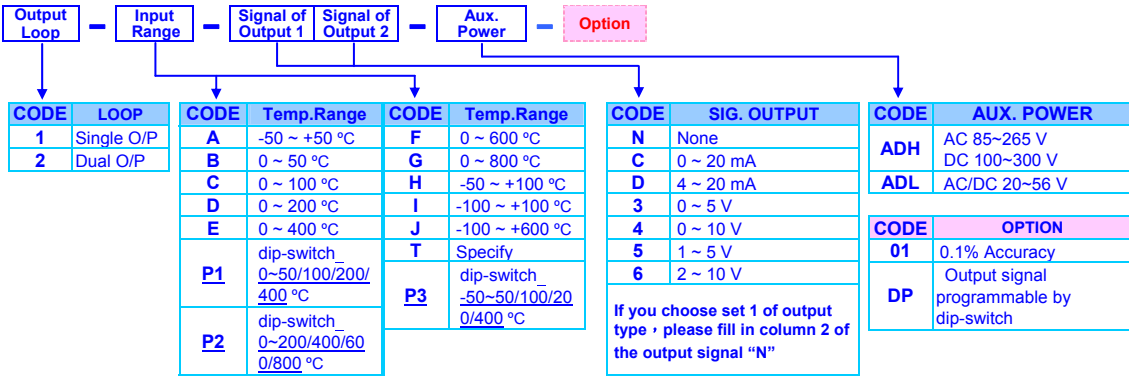

AT-TC

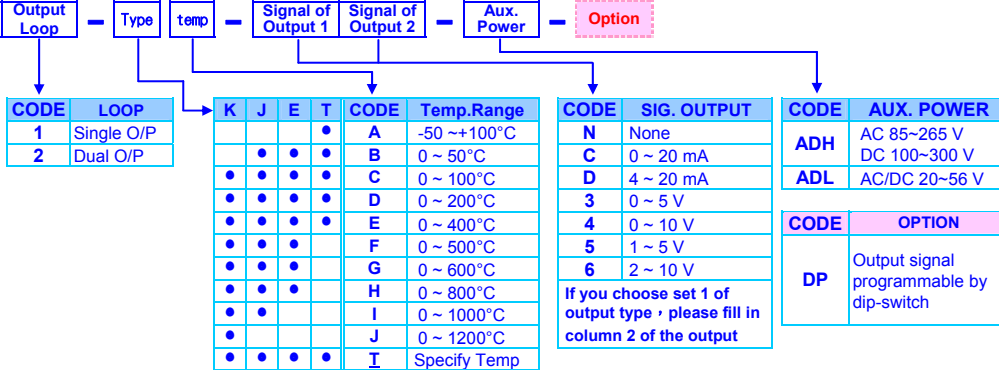

AT-PM

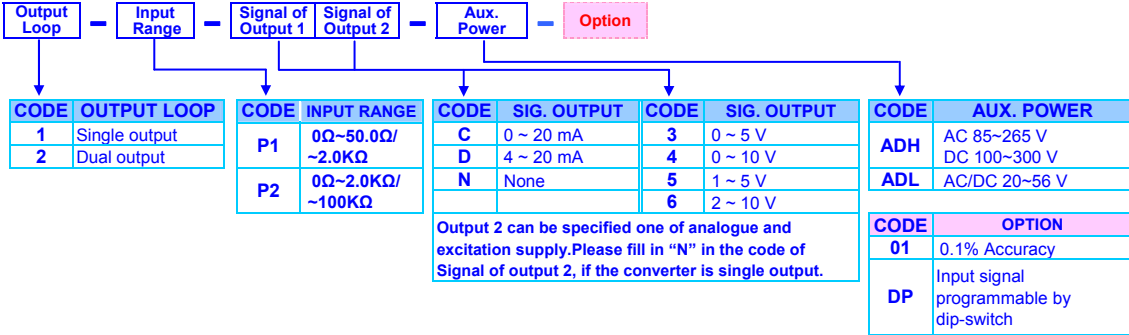

AT-RS

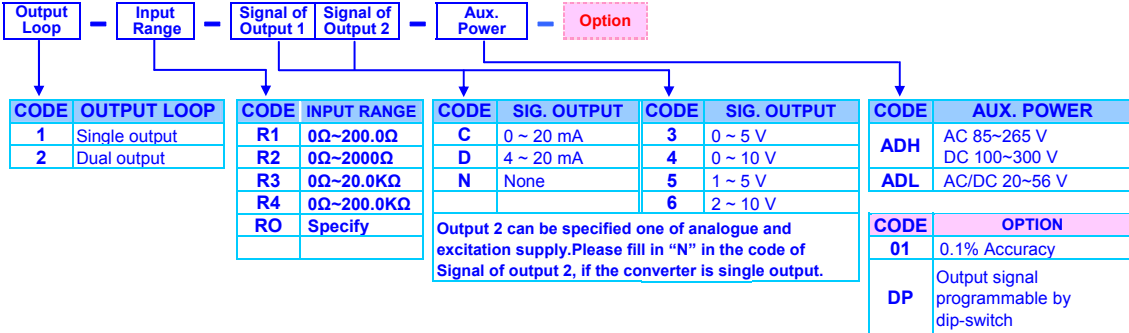

AT-SG

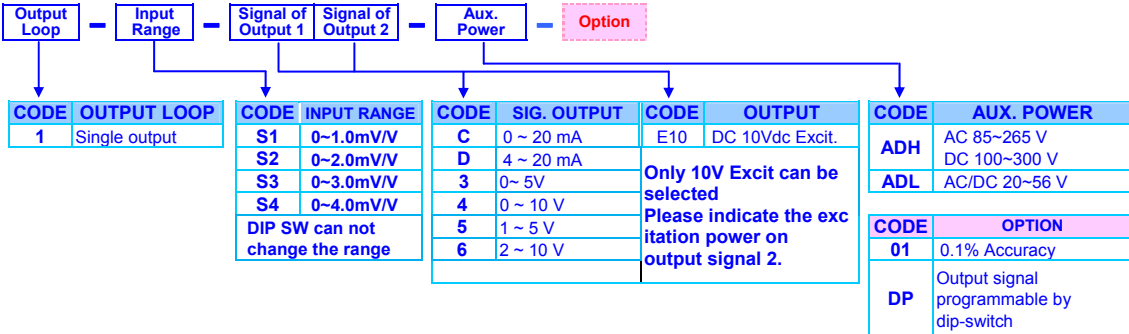

■ TECHNICAL SPECIFICATION

Input Signal (Can be specified dip-switch programmable – option “DP”)

AT-VA(Voltage or Current)

Input range DC / AC	Input Impedance	Input range DC / AC	Input Impedance
Voltage	0~50/~100 mV	Current	0~1.999 mA
	0~199.9 mV		0~19.99 mA
	0~1.999 V		0~199.9 mA
	0~19.99 V		0~1.999 A
	0~199.9 V		0~5.000 A
	0~300.0 V		
0~500.0 V			

Accuracy: AC: $\leq \pm 0.5\%$ of F.S.(delivered in customer's specify)
 DC: $\leq \pm 0.2\%$ of F.S.(delivered in customer's specify)
 DC: $\leq \pm 0.1\%$ of F.S.(delivered in customer's specify)
 $\leq \pm 2\%$ of F.S.(By Dip-switch)

Input burden: AC Current: ≤ 0.1 VA; AC Voltage: ≤ 0.15 VA

AT-PR(0~10V/4~20mA)

Input Range (Selected by terminals)	Input Signal (Changeable by dip-switch)	Input Impedance
0/4 ~ 20 mA (terminal 3+ & 2-)	0~20mA, 4~20mA	250Ω
0 ~ 10 V (terminal 1+ & 2-)	0~5V, 0~10V, 1~5V, 2~10V	1MΩ

Standard: Can not change the input / output signal, please specify in order

Accuracy: $\leq \pm 0.2\%$ of F.S.(delivered in customer's specify)
 $\leq \pm 0.1\%$ of F.S.(Option)
 $\leq \pm 2\%$ of F.S.(By Dip-switch)

AT-TR (Pt100Ω)

Input Range	Input Signal (Changeable by dip-switch)	Input Impedance
Pt100Ω (DIN)	P1 0~50 / 100 / 200 / 400 °C	Selected by Dip-Switch 1MΩ
	P2 0~200 / 400 / 600 / 800 °C	
	P3 -50~50 / 100 / 200 / 400 °C	

Standard: please specify in order

Accuracy: $\leq \pm 0.2\%$ of F.S.(delivered in customer's specify)
 $\leq \pm 0.1\%$ of F.S.(Option)
 $\leq \pm 2\%$ of F.S.(By Dip-switch)

AT-TC (Pt100Ω)

Type	Measuring Range	Input Impedanc	Type	Measuring Range	Input Impedanc
K	0~1200°C	1MΩ	E	0~800°C	1MΩ
J	0~1000°C	1MΩ	T	-100~400°C	1MΩ

Accuracy: $\leq \pm 0.5\%$ of F.S.(delivered in customer's specify)
 Cold Junction: $25 \pm 10^\circ\text{C}$, error $\leq 0.5^\circ\text{C}$

AT-PM (Potentio-Meter)

Input Signal	Input Impedanc
P1 0Ω~50.0Ω/~2.0KΩ	1MΩ
P2 0Ω~2.0KΩ/~100.0KΩ	1MΩ

Accuracy: $\leq \pm 0.2\%$ of F.S.(delivered in customer's specify)
 $\leq \pm 0.1\%$ of F.S.(Option)

Detect Voltage: 1.6V

AT-RS (Resistance)

Input Range	Input Impedanc	Input Range	Input Impedanc
R1 0.0Ω~200.0 Ω	1MΩ	R3 0.0Ω~20.0 KΩ	1MΩ
R2 0.0Ω~2000.0 Ω	1MΩ	R4 0.0Ω~200.0 KΩ	1MΩ

Accuracy: $\leq \pm 0.2\%$ of F.S.(delivered in customer's specify)
 $\leq \pm 0.1\%$ of F.S.(Option)

Detect Current: 1.6mA

AT-SG (Strain Gauge)

Input Range	Input Impedanc	Input Range	Input Impedanc
S1 0.0~1.0mV/V	1MΩ	S3 0.0~3.0 mV/V	1MΩ
S2 0.0~2.0mV/V	1MΩ	S4 0.0~4.0 mV/V	1MΩ

Accuracy: $\leq \pm 0.2\%$ of F.S.(delivered in customer's specify)
 $\leq \pm 0.1\%$ of F.S.(Option)

Excitation power: 10V/30mA

output Signal (Can be specified dip-switch programmable – option “DP”)

output range	output Impedance	output Signal (Changeable by dip-switch)
0 ~ 20mAdc	$\leq 520\Omega$	Output 1: Io(mA output - terminal 9+ & 8-) Output 1: Vo(V output - terminal 7+ & 8-)
4 ~ 20mAdc	$\leq 520\Omega$	
0 ~ 10Vdc	$\geq 1000\Omega$	
2 ~ 10Vdc	$\geq 1000\Omega$	Output 2: Io(mA output - terminal 12+ & 11-) Output 2: Vo(V output - terminal 10+ & 11-)
0 ~ 5Vdc	$\geq 500\Omega$	
1 ~ 5Vdc	$\geq 500\Omega$	

Standard: please specify in order

Response Time: PR \ TR: ≤ 250 msec (Input10%~Output90% of FS)
 SG \ VA(DC): ≤ 300 msec(Input10%~Output90% of FS)
 TC \ VA(AC): ≤ 500 msec(Input10%~Output90% of FS)

Output ripple: $\leq \pm 0.1\%$ of F.S.

Span Calibration range: $\leq \pm 10\%$ of F.S. · 2 group individually adjusted

Zero Calibration range: $\leq \pm 10\%$ of F.S. · 2 group individually adjusted

Isolation: AC 2.0 KV ; Between output 1 & output 2

Excit. Power: DC 24V, 30mA

DC 10V, 30mA

Power

Power supply AC 85~265V/DC 100~300V, 50/60Hz

Power consumption: DC 4W, AC 6.0VA

Environmental

Operating temp.: 0~60 °C

Operating humi.: 20~95% RH, Non-condensing

Temp. Coefficient: ≤ 100 PPM/ °C (0~50 °C)

Storage temp.: -10~70 °C

Protection: IP 42

Vibration: 1~800 Hz, 3.175 g²/Hz

Mechanical

Dimensions: 94.0mm x 94.0mm x 17.5mm

Housing: ABS -Fireproof materials · UL94V0

Terminals: Pluggable terminal block,

M2.5 Screw · connect 2 x 2.5mm² wire

35mm DIN rail (EN50022)

Mounting: 250g

Specification

Electrical Safety(LVD): IEC 61010 (Installation category 3)

EMC: EN 55011:2002; EN 61326:2003

Electric Isolation: AC 2.0KV · for 1min,
 Between Power / Input / Output1 / Output2 / Case

Insulation resistance: ≥ 100 MΩ at 500Vdc, Between Power / Input / Output

EMI: EN 55011:2002; EN 61326:2003

Status Indication

I/O Status Indication: 3 or 4 round LED indication

Power on, LED bright

Input signal $\geq 4\sim 6\%$, LED bright

output 1 and output 2 signal $\geq 4\sim 6\%$, LED bright

DIMENSIONS

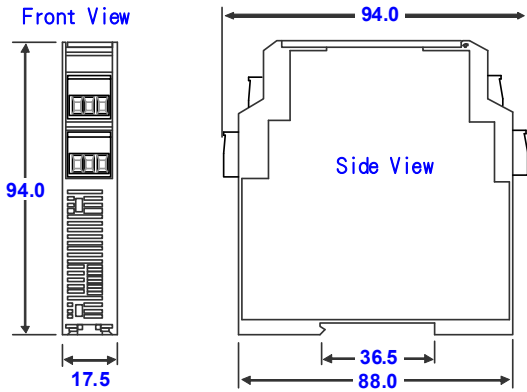

TOP PANEL

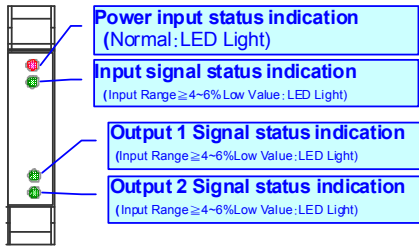

INSTALLATION

The converter should be installed in a location that does not exceed the maximum operating temperature and provides good air circulation.

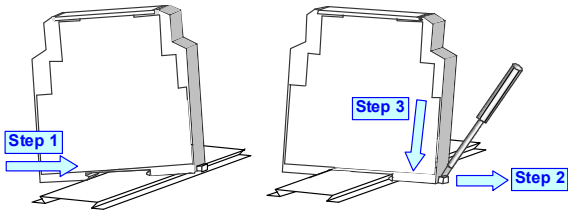

ADJUSTMENT

Customer can specify AT series with dip switch in optional code (-DP) for change of input and output range to save stock.

⚠ Recalibration is recommended after change range.

Signal input change table (by dip switches - option)

The input of AT-VA(AC/DC voltage and Current) can not be changed

AT-PR(0~10V/4~20mA)

Input signal: Input range	Dip-Switch (ZC)			
	SW1	SW2	SW3	SW4
0 ~ 5 V				
0 ~ 10 V		on		
1 ~ 5 V			on	on
2 ~ 10 V		on	on	on
0 ~ 20 mA	on			
4 ~ 20 mA	on		on	on

AT-TR(Pt100Ω)

Input Signal : Pt100Ω(Code:P1)

Signal Range	Dip-Switches - ZB1						Dip-Switches - ZC1			
	SW1	SW2	SW3	SW4	SW5	SW6	SW1	SW2	SW3	SW4
0 ~ 50°C							on			
0 ~ 100°C	on					on		on		
0 ~ 200°C		on				on			on	
0 ~ 400°C			on							on

Input Signal : Pt100Ω(Code:P2)

Signal Range	Dip-Switches - ZB1						Dip-Switches - ZC1			
	SW1	SW2	SW3	SW4	SW5	SW6	SW1	SW2	SW3	SW4
0 ~ 200°C				on			on			
0 ~ 400°C	on					on		on		
0 ~ 600°C		on				on			on	
0 ~ 800°C			on							on

Input Signal : Pt100Ω(Code:P3)

Signal Range	Dip-Switches - ZB1						Dip-Switches - ZC1			
	SW1	SW2	SW3	SW4	SW5	SW6	SW1	SW2	SW3	SW4
-50 ~ 50°C				on			on			
-50 ~ 100°C	on					on		on		
-50 ~ 200°C		on				on			on	
-50 ~ 400°C			on							on

AT-PM(Potentiometer (3 wire))

Input Signal : Potentiometer

Signal Range	Dip-Switches - ZC1			
	SW1	SW2	SW3	SW4
0~50KΩ/~2.0KΩ	on	on		on
0~2.0KΩ/~100KΩ	on	on		on

AT-RS(Resistance (2 wire))

Input Signal : Resistance

Signal Range	Dip-Switches - ZB1					
	SW1	SW2	SW3	SW4	SW5	SW6
0 ~ 200Ω	on	on				
0 ~ 2000Ω	on	on			on	
0 ~ 20.0KΩ	on	on		on		
0 ~ 200.0KΩ	on	on	on			

Output signal switching sheet (dip-switch- option)

Output signal :

Output range	Dip-Switches - ZB/ZA					
	Output 1(ZB) / Output 2(ZA)					
	SW1	SW2	SW3	SW4	SW5	SW6
0 ~ 5 V		on	on	on		on
0 ~ 10 V		on		on		on
1 ~ 5 V	on		on	on		on
2 ~ 10 V	on			on		on
0 ~ 20 mA		on			on	
4 ~ 20 mA	on				on	

Output signal switching sheet (dip-switch- option)Adjustment

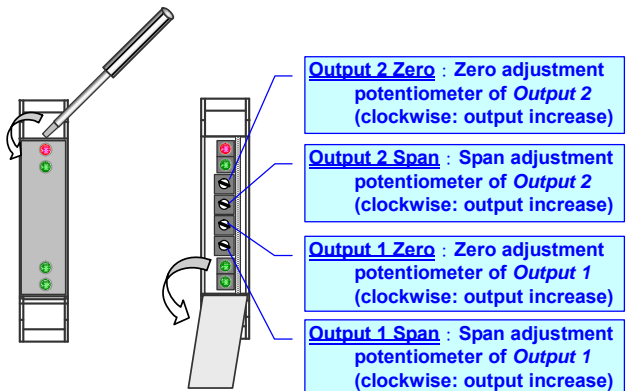

CONNECTION DIAGRAM

The converter has been designed pluggable terminal blocks
 Rated voltage: 300V Rated current: 12A
 Solid wire (AWG): 28~12 Wire strip length: 7~8mm
 Screw: M2.5 Torque: 5.0 Kg-cm

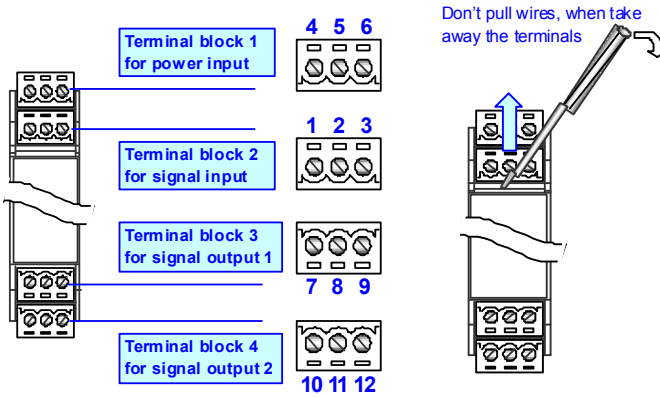

Auxiliary power connection – Terminal block 1

Please check the voltage of power supplied first, and then connect to the specified terminals the meter be protected by a fuse or circuit breaker.

The connection is maybe change. Please refer to the connection on the label of products

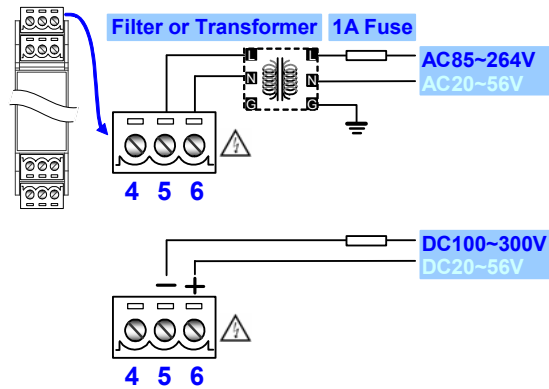

Input signal – Terminal block 2

The converter can be input and output mA and V that depends on the difference terminals wiring.

AT-VA(AC \ DC Vo | tage/Current) **AT-PR(0~10V/4~20mA)**

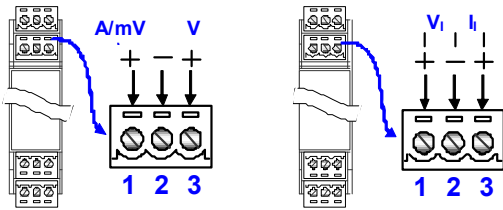

AT-TR(Pt100Ω) **AT-TC(Thermocouple)**

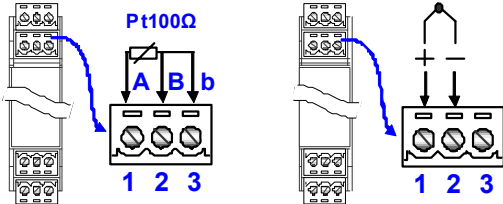

AT-PM(Potential-meter-3 wire) **AT-RS(Resistance-2 wire)**

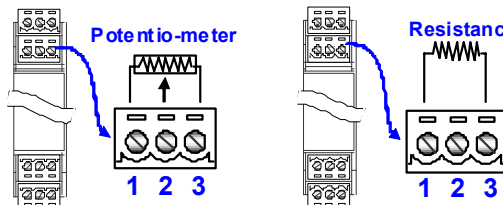

Output signal 1 & 2 – Terminal block 3 & 4

OPTION "DP" Function · The converter can be output mA and V that depends on the terminals wiring. (by Dip-switch)

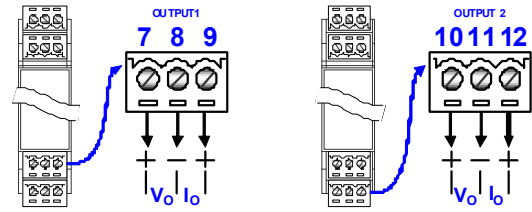

Excitation supply DC24V – Terminal block 4

Output 2 can be specified one of analogue and excitation supply

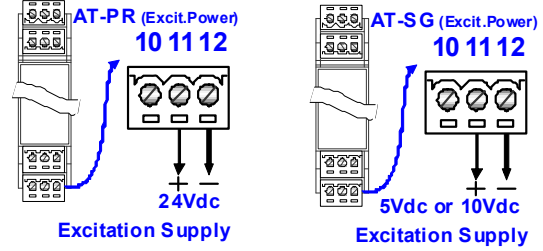

AT-SG WIRING

