

VAM VOLT & CURRENT Meter (Dual Input & Display)

DESCRIPTION

VAM Voltage & Current Meter has been designed with high accuracy dual channels(isolated) measurement, dual display and communication of 0~600V and 0~10A for DC/AC/TRMS. In compact size(48 x 96mm)

☑ Build in mathematic function such as Addition / Subtraction / Multiplication / Division / high or low selector in 2 channels input to meet various testing equipment inquiry.

They are also build in 4 Relay outputs, 1 Analogue output and 1 RS485(Modbus RTU Mode) interface with versatile functions such as control, alarm, re-transmission and communication for a wide range of industrial applications.



FEATURE

- Measuring dual channels (isolated) Voltage 0~100mV/~600V and Current 0~199.99µA/~10A for DC / AC / TRMS mixable.
- Mathematic function available for Addition / Subtraction / Multiplication / Division / high or low selector in 2 channels input in option.
- 4 relay can be multi-cross programmed individual to be a Hi / Lo / Hi Latch / Lo Latch / Go energized with Start Delay / Hysteresis / Energized & De-energized Delay functions, or to be a remote control.
- Analogue multi-cross selection output and RS 485 communication port in option
- CE Approved

APPLICATIONS

- Testing Equipments for Volt/Current Measuring, Alarm, Control and Communication with PC/PLC
 - ☑ 4 Relay functions as like as Hi / Lo / Go with on and off delay time from 0.0(s)~ 9(m):59.9(s)
- DC watt measuring in solar energy to communicate with PC/PLC
 - ☑ Multiple function for input 1(Adc) and input2(Vdc)
- MCC panel, Machinery, Switch gear... for Voltage or Current Measuring, Alarm and Remote I/O with PC/PLC
 - ☑ Fantastic 4 Relay functions as like as Hi / Lo / Hi latch / Lo latch / DO(Remote control by PC/PLC).

ORDERING INFORMATION

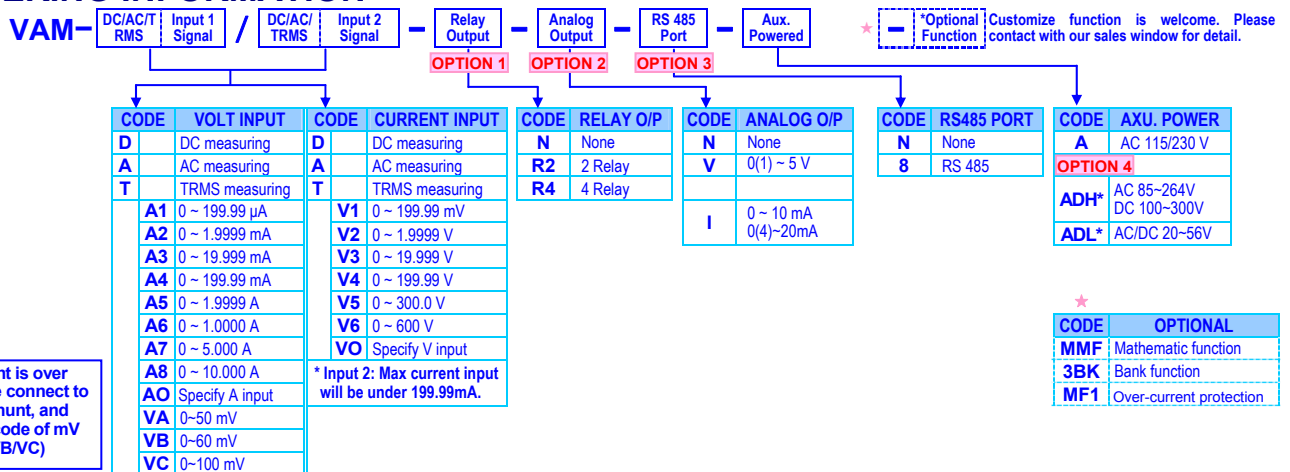

TECHNICAL SPECIFICATION

Input

Measuring Range DC / AC / TRMS	Input Impedance	Measuring Range DC / AC / TRMS	Input Impedance
Voltage		Current	
0~50/~100 mV	≥5M ohm	0~199.99µA	1K ohm
0~199.99 mV	≥5M ohm	0~1.9999 mA	100 ohm
0~1.9999 V	≥1M ohm	0~19.999 mA	10 ohm
0~19.999 V	≥1M ohm	0~199.99 mA	1 ohm
0~199.99 V	≥1M ohm	0~1.9999 A	0.05 ohm
0~300.0 V	≥2M ohm	0~5.000 A	0.02 ohm
0~600.0 V	≥2M ohm	0~10.000 A	0.01 ohm

★ Dual inputs can be selected individual in Voltage & Current for DC, AC or TRMS measuring.

★ The dual input can be specified individual in other signal such as Pt100Ω, mV/V etc.

Calibration:

A/D converter:

Accuracy:

Sampling rate:

Response time:

Input range:

Display & Functions

LED:

Digital calibration by front key for each channel

16 bits resolution

DC: ≤± 0.04% of FS ± 1C

AC: ≤± 0.1% of FS ± 1C

15 cycles/sec

≤ 100 msec.(when the AvG = "1") in standard

Input High and Low programmable for each channel

R \uparrow H : Settable range: 0.00~100.00% of input range

R \downarrow L : Settable range: 0.00~100.00% of input range

Numeric: Dual display screen, 5 digits, 0.4"(10.0mm)H red high-brightness LED

Relay output indication: 4 square red LED

RS 485 communication: 1 square orange LED

Dual display screens: Dual screens can be programming individual
Display range: PV: -19999~29999; Mathematic: -19999~+99999
Scaling function: **Individual programmable for dual input**
Lo.SC: Low Scale; Settable range: -19999~+29999
Hi.SC: High Scale; Settable range: -19999~+29999
 Programmable from 0 / 0.0 / 0.00 / 0.000 / 0.0000
Overflow: when input is over than 20% of input range Hi
Underflow: when input is under than 20% of input range Lo
Maximum / Minimum recording: Maximum and Minimum value storage during power on.
Display functions: PV / Max(Mini) Hold / RS 485 Programmable
 Multi-cross selection for dual screens.
Mathematic functions: Programmable for Addition / Subtraction /
 (Option) Multiplication / Division / High or Low selector
Front key functions: Relative PV / PV Hold / Reset for maxi(mini) hold /
 Reset for relay energized latch programmable
Low cut: Settable range: -19999~29999 counts
Digital fine adjust: **PuPp:** Settable range: -19999~+29999
PuSPn: Settable range: -19999~+29999

Reading Stable Function
Average: Settable range: 1~99 times
Moving average: Settable range: 1(None)~10 times
Digital filter: Settable range: 0(None)/1~99 times

Control Functions(option)
Set-points: Four set-points
Control relay: Four relays
 Relay 2 & Relay 3: Dual FORM-C, 1A/230Vac, 3A/115V
 Relay 1 & Relay 4: Dual FORM-A, 1A/230Vac, 3A/115V
Relay energized mode: **Multi-Cross selection with display 1 & display 2**
 Energized levels compare with set-points:
 Hi / Lo / Go.12 / Go.23 / Hi.HLd / Lo.HLd; programmable
Energizing functions: **DO function: Energized by RS485 command of master.**
 Start delay / Energized & De-energized delay / Hysteresis /
 Energized Latch
Start band(Minimum level for Energizing): 0~9999counts
Start delay time: 0:00.0~9(Minutes):59.9(Second)
Energized delay time: 0:00.0~9(Minutes):59.9(Second)
De-energized delay time: 0:00.0~9(Minutes):59.9(Second)
Hysteresis: 0~5000 counts

Analogue output(option)
Accuracy: $\pm 0.1\%$ of F.S.; 16 bits DA converter
Ripple: $\pm 0.1\%$ of F.S.
Response time: ≤ 100 msec. (10~90% of input)
Isolation: AC 2.0 KV between input and output
Output range: Specify either Voltage or Current output in ordering
Voltage: 0~5V / 0~10V / 1~5V programmable
Current: 0~10mA / 0~20mA / 4~20mA programmable
Output capability: **Voltage: 0~10V; $\geq 1000\Omega$;**
Current: 4(0)~20mA; $\leq 600\Omega$ max
Functions: **Multi-Cross selection to relative display 1 & display 2**
RaHS (output range high): Settable range: -19999~29999
RaLS (output range Low): Settable range: -19999~29999
RaLHt (output High Limit): 0.00~110.00% of output High
High/Low Selection output: The output will compare
 the 2 inputs which one is High(or Low) and tracking
 output.

Digital fine adjust: **RaPp:** Settable range: -38011~+27524
RaSPn: Settable range: -38011~+27524

RS 485 Communication(option)
Protocol: Modbus RTU mode
Baud rate: 1200/2400/4800/9600/19200/38400 programmable
Data bits: 8 bits
Parity: Even, odd or none (with 1 or 2 stop bit) programmable
Address: 1 ~ 255 programmable
Remote display: to show the value from RS485 command of master
Distance: 1200M
Terminate resistor: 150 Ω at last unit.

Electrical Safety
Dielectric strength: AC 2.0 KV for 1 min,
 Between Power / Input 1 / Input 2 / Output / Case
Insulation resistance: $\geq 100\Omega$ ohm at 500Vdc, Between Power / Input / Output
Isolation: Between Power / Input 1 / Input 2 / Relay / Analogue / RS485
EMC: EN 55011:2002; EN 61326:2003
Safety(LVD): EN 61010-1:2001

Environmental
Operating temp.: 0~60 °C
Operating humidity: 20~95 %RH, Non-condensing
Temp. coefficient: ≤ 100 PPM/°C
Storage temp.: -10~70 °C
Enclosure: Front panel: IEC 529 (IP52); Housing: IP20

Mechanical
Dimensions: 96mm(W) x 48mm(H) x 120mm(D)
Panel cutout: 92mm(W) x 44mm(H)
Case material: ABS fire-resistance (UL 94V-0)
Mounting: Panel flush mounting
Terminal block: Plastic NYLON 66 (UL 94V-0)
 #A1~A3(current input): 20A/300Vac, M3.5, 12~22AWG
 Others: 10A 300Vac, M2.6, 16~22AWG
 550g / 350g(Aux. Power Code: ADH or ADL)

Power
Power supply: AC115/230V,50/60Hz;
Optional: AC 85~264V / DC 100~300V
or AC/DC 20~56V

Power consumption: 7.0VA maximum
Back up memory: By EEPROM

FRONT PANEL

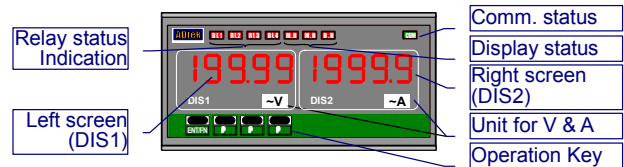

DIMENSIONS

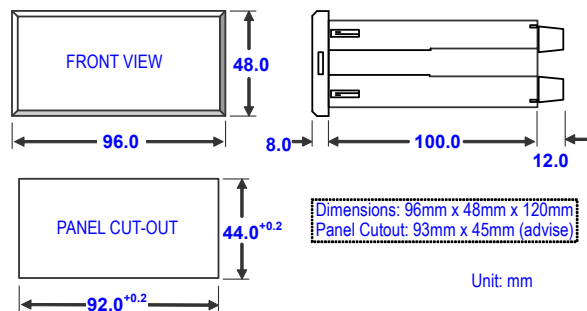

INSTALLATION

The meter should be installed in a location that dose not exceed the maximum operating temperature and provides good air circulation.

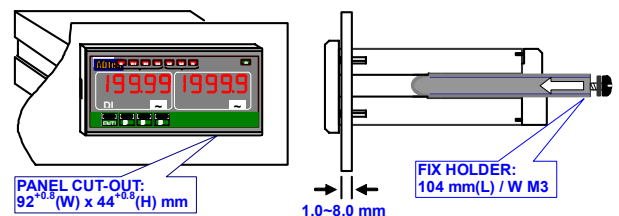

CONNECTION DIAGRAM

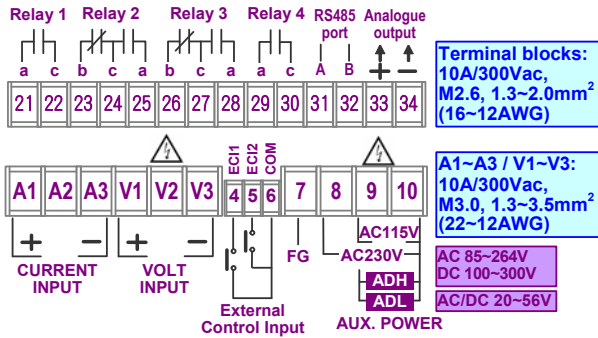

Please check the voltage of power supplied first, and then connect to the specified terminals. It is recommended that power supplied to the meter be protected by a fuse or circuit breaker.

Power Supply

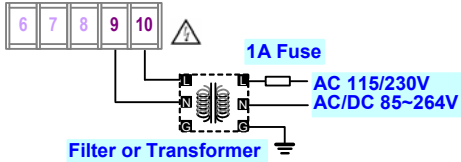

Input connection

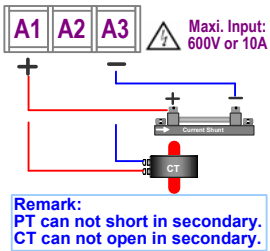

RS485 Communication Port

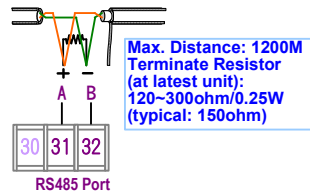

FUNCTION DESCRIPTION

Input & Scaling Functions

Input range(individual for each channel):

The meter has to be specified and fixed according to ordering code (ex. 0~10A or 0~300V) in factory. If the meter has to install in difference range of input, the meter can be set in function [R.LO] and [R.HI] of input group to meet the input signal.

For example: The meter is 0~10Aac input, and the signal from sensor is 0~5Aac. Please get into [mPUt GrOUP] to set [R.HI] (Analogue input high) to be 50.00%(10A x 50.00% = 5A), then the meter has been changed the input range to 0~5A and the all relative parameters will work base on 0~5A. The meter doesn't need re-calibration after change the [R.LO] and [R.HI].

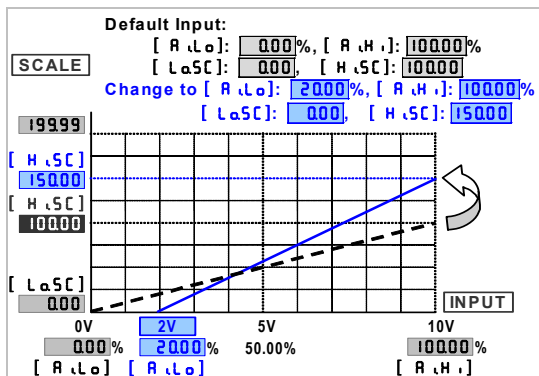

Scaling function(individual for each display screen):

Setting the [L.a.S.C](Low scale) and [H.s.C](High scale) in [mPUt GrOUP] to relative input signal. Reverse scaling will be done too. Please refer to the figure as below,

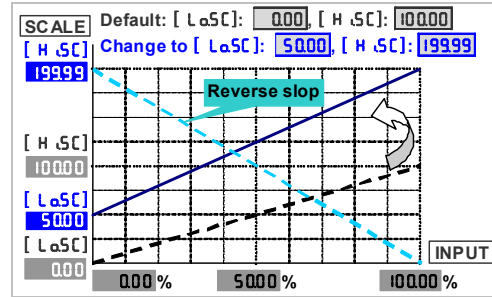

*Too narrow scale may cause display lower resolution.

Display & Functions

Multi-Cross Function selection:

VAM has 2 isolated input relative 2 screens with Multi-Cross Functions in difference purposes.

EX: The meter can be set:

DIS1 relative INPUT1, DIS2 relative INPUT1 X INPUT2

or

DIS1 relative INPUT1 ÷ INPUT2

DIS1 shows value from RS485 command to write in.

Mathematics Function:

The displays can be set to show the mathematics + - X ÷ in 2 isolated input

Max / Mini recording:

The meter will storage the maximum and minimum value for each display screen in [User Level] during power on in order to review drifting of PV.

Display functions:

(Please refer to step A-10)

PV / Max(Mini) Hold / RS 485 programmable in [d5PLy] function of [mPUt GrOUP] for each display screen.

Present Value [Pv]: The display will show the value that Relative to Input signal.

Maximum Hold [MxHld] / Minimum Hold [MnHld]:

The meter will keep display in maximum(minimum) value during power on, until manual reset by front key in [User Level], or press front down key (Down function has to set [r5t]).

➤ Please find the [MLH] sticker that enclosure the package of the meter to stick on the up side of square orange LED

Max. (Mini) Hold & Reset

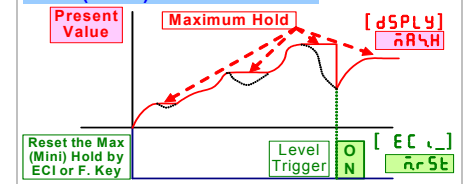

Remote Display by RS485 command [5485]: The meter will show the value that received from RS485 sending. In past, The meter normally receive 4~20mA or 0~10V from AO or digital output from BCD module of PLC. We support a new solution that PV shows the value from RS485 command of master can so that can be save cost and wiring from PLC.

PV Hold [PvHld]: Down key function can be set to be [PvHld] function. The display will be hold, when down key has to be pressed.

➤ Please find the [E.C.I.] sticker to stick on the up side of square green LED.

PV Hold & Reset

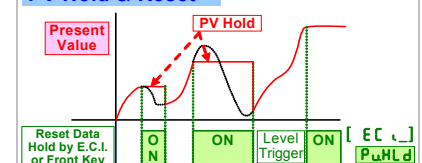

Low cut(individual for each display screen):

If the setting value is positive, it means when the absolutely value of PV ≤ Setting value, the display will be 0. If the setting value is negative, it means when the PV under setting value (PV ≤ -Setting value), the display will be setting value.

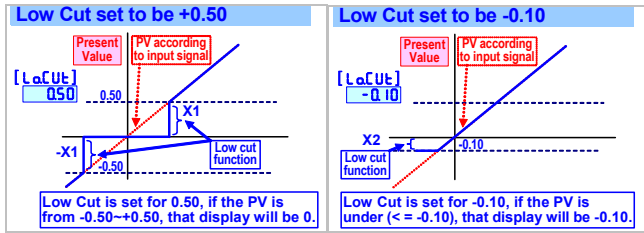

Digital fine adjustment(individual for each display screen):

Users can get Fine Adjustment for Zero & Span of PV by front key of the meter, and "Just Key In" the value which user want to show in the current input signals.

Especially, the [P_uP_r_o] & [P_uS_P_n] are not only in zero & span of PV, but also any lower point for [P_uP_r_o] & higher point for [P_uS_P_n]. The meter will be linearization for full scale.

The adjustment can be clear in function [P_S_C_L_r].

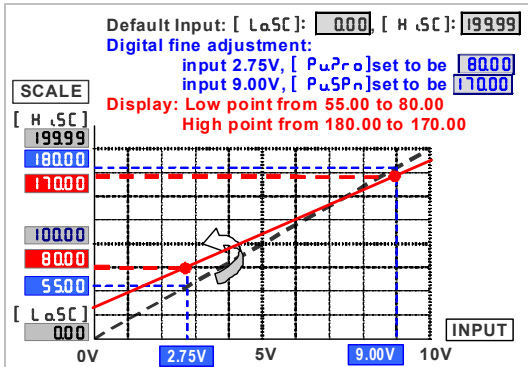

Front key functions:

Relative PV / PV Hold / Reset for maxi(mini) hold / Reset for relay energized latch programmable in [d_nE_Y] function of [inPUt GrOuP]

Relative PV [ELP_u] : [d_nE_Y] function can be be [ELP_u] function. When user press the set to key, the display will show the differential value(ΔPV), until press key again.

➢ Please find the [RPV] sticker to stick on the up side of square red LED.

PV Hold [P_uH_L_d] : [d_nE_Y] function can be set to be [P_uH_L_d] function. When user press the key, the display will be hold until press the key again.

➢ Please find the [P_uH] sticker to stick on the up side of square red LED.

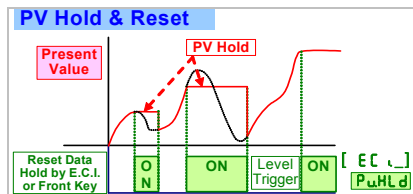

Reset for Max(Mini) Hold: when the [d_SPL_Y] in [inPUt GrOuP] set to be [P_uH_L_d] or [P_uH_L_d], [d_nE_Y] function can be set to be [P_uH_L_d] to reset the display when it is holding in maxim or mini value.

Reset for relay energized latch: when the [r_Y_l_n_d] in [r_E_L_A_Y GrOuP] set to be [P_uH_L_d] or [P_uH_L_d], [d_nE_Y] function can be set to be [P_uH_L_d] to reset the relay when it is energizing and latching.

Reading Stable Function

Average:

Basically, the sampling rate of meter is 15cycles/sec. If the function set to be 3 times, It means the meter will update of display will be 5 times/sec.

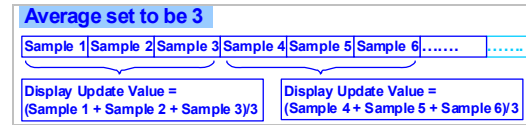

Moving average:

If the function to be set 3 times, the meter will update delay in first 3 samples, then it will update 15 times/sec continuously.

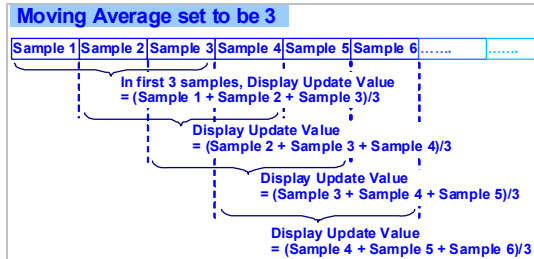

Digital Filter:

The digital filter can reduce the magnetic noise in field.

Control Functions(option)

The VAM can be specified 4 relay output. Each relay can be multi-cross programmed to relative display 1 or display 2.

Relay energized mode:

Hi / Lo / Hi.HLd / Lo.HLd / do / Go-1.2 / Go-2.3 programmable

Hi: Relay will energize when PV > Set-Point

Lo: Relay will energize when PV < Set-Point

Go-1.2: This function is programmable in Relay 4 only.

If the Relay 4 set to be Go function, the relay will compare with [r_Y_lSP] and [r_Y2SP].

Go relay energized when the condition is [r_Y_lSP] (Hi) > PV > [r_Y2SP] (Lo)

Go-2.3: This function is programmable in Relay 4 only.

If the Relay 4 set to be Go function, the relay will compare with [r_Y2SP] and [r_Y3SP].

Go relay energized when the condition is [r_Y2SP] (Hi) > PV > [r_Y3SP] (Lo)

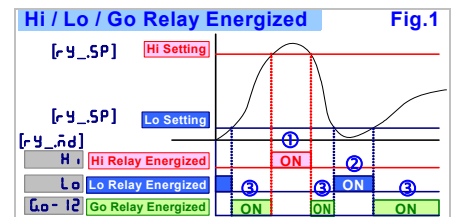

Hi.HLd (Lo.HLd): When the PV is Higher (or lower) than set-point, the relay will be energized and latch until manual reset by from key in [User Level] or press front down key to reset (Down function has to set [r_Y_rSt]).

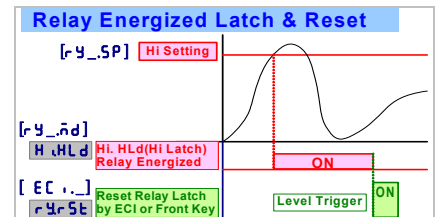

DO function: Energized by RS485 command of master.

The function was designed to get remote control by RS485 command of master. The typical application is to control a switch in field from computer center as like as digital output(DO) of PLC.

Energized Functions: Start delay / Energized & De-energized delay / Hysteresis
Please refer to figure as below

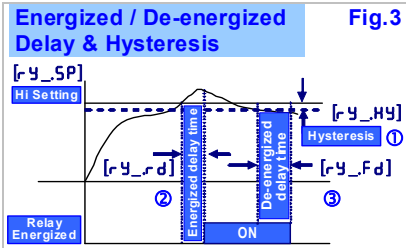
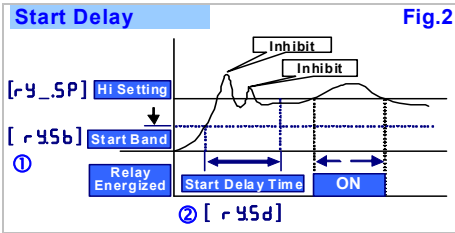

Ao.LMt(output High Limit): 0.00~110.00% of output High
User can set the high limit of output to avoid a damage of receiver or protection system.

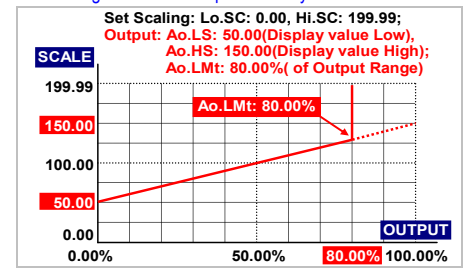

Fine zero & span adjustment:

Users can get Fine Adjustment of analogue output by front key of the meter. Please connect standard meter to the terminal of analogue output. To press the front key(up or down key) of meter to adjust and check the output.

- [RoZro] : Fine Zero Adjustment for Analog Output; Settable range: -38011~27524;
- [RoSPn] : Fine Span Adjustment for Analog Output; Settable range: -38011~27524;

External control input(ECI)

VAM offers 2 point external control inputs (ECI). They can be programmable individual with multi display and control functions. The front key function can be set to execute ECI function, but ECI terminals will be disabling. The ECI terminal input was designed by level trigger. Please refer to description as below,

Functions:

Relative PV / PV Hold / Reset Max or Mini. Hold / DI / Reset for Relay Energized latch / banks selection(option) programmable.
Relative PV or Tare: The [EC] can be set to the [ELP] (Relative PV) function. When the ECI is closed, the reading will show the differential value with PV. Please refer to Display function section previously.

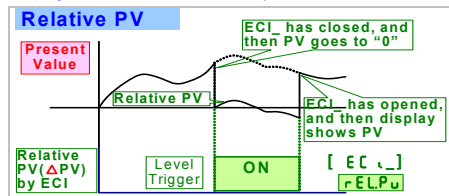

PV Hold: The E.C.I. can be set to be [P.H.Ld] function. The display will be hold when the E.C.I. is closed, until the ECI is to be open. Please refer to the below figure.

Analogue output(option)

The analogue output can be programmed to relative display 1 or display 2. Please specify the output type either an 0~10V or 4(0)~20mA in ordering. The programmable output low and high scaling can be based on various display values. Reverse slope output is possible by reversing point positions.

Output range:

Voltage: 0~5V / 0~10V / 1~5V programmable
Current: 0~10mA / 0~20mA / 4~20mA programmable

Functions:

RoHS (output range high): setting the Display value High to versus output range High(as like as 20mA in 4~20)
RoLS (output range Low): setting the Display value Low to versus output range Low(as like as 4mA in 4~20)

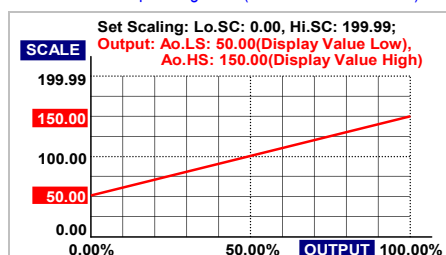

The range between **RoHS** and **RoLS** should be over 20% of span at least; otherwise, it will be got less resolution of analogue output.

RS 485 communication(option)

The RS485's protocol is Modbus RTU mode, and baud rate up to 38400 bps. It's not only convenience to remote monitoring, display for reading and ECI status, but also for remote control in the case that doesn't have any DIO device in the field.

APPLICATION FOR VOLTAGE / CURRENT & FREQUENCY MEASURING & RS485 COMM.

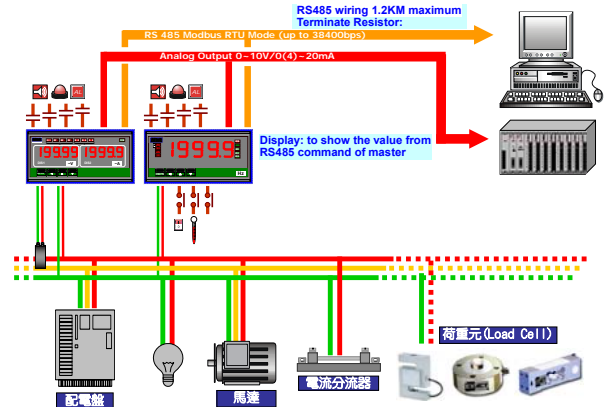

Remote Display:

The meter will show the value that received from RS485 command. In past, The meter normally receive 4~20mA or 0~10V from AO or digital output from BCD module of PLC. We support a new solution that PV shows the value from RS485 command of master so that can be **save cost and wiring** from PLC.

When the [dSPly] set to be RS485, it means, the PV screen will show the number from RS485 command & data. The data(number) will be same as PV that will compare with set-point, analogue output and ECI functions so that is to control analogue output, relay energized and so on.

CS2 APPLICATION FOR REMOTE DISPLAY FROM RS485 COMMAND

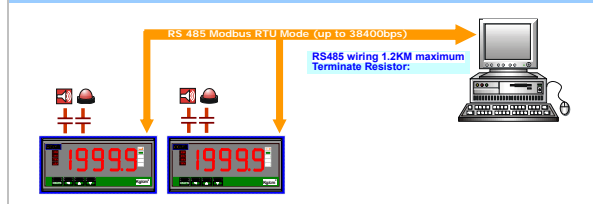

Calibration

System calibration by front key. The process of calibration, please refer to the operating manual

■ ERROR MESSAGE

BEFORE POWER ON, PLEASE CHECK THE SPECIFICATION AND CONNECTION AGAIN.

SELF-DIAGNOSIS AND ERROR CODE:

DISPLAY	DESCRIPTION	REMARK
ouFL	Display is positive-overflow (Signal is over display range)	(Please check the input signal)
-ouFL	Display is negative-overflow (Signal is under display range)	(Please check the input signal)
ouFL	ADC is positive-overflow (Signal is higher than input 120%)	(Please check the input signal)
-ouFL	ADC is negative-overflow (Signal is lower than input -120%)	(Please check the input signal)
EEP ↔ FA.LL	EEPROM occurs error	(Please send back to manufactory for repaired)
A.i.C.nG ↔ Pu	Calibrating Input Signal do not process	(Please process Calibrating Input Signal)
A.i.C ↔ FA.LL	Calibrating Input Signal error	(Please check Calibrating Input Signal)
A.o.C.nG ↔ Pu	Calibrating Output Signal do not process	(Please process Calibrating Output Signal)
A.o.C ↔ FA.LL	Calibrating Output Signal error	(Please check Calibrating Output Signal)

■ FRONT PANEL:

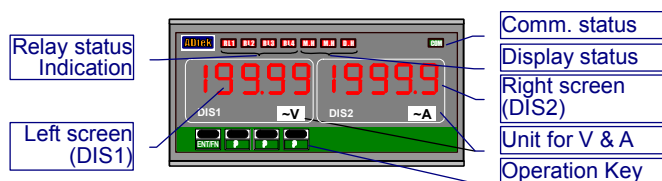

VAM has two display screens and I/O status indication for purposes.

■ Numeric Screens

- **Left screen:** 0.4"(10.0cm) red high-brightness LED for 5 digits to relative input 1 or mathematic.
- **Right screen:** 0.4"(10.0cm) red high-brightness LED for 5 digits to relative input 2 or mathematic.

■ I/O Status Indication

- **Relay Energized:** 4 square red square LED
 - RL1** display when Relay 1 energized;
 - RL2** display when Relay 2 energized;
 - RL3** display when Relay 3 energized;
 - RL4** display when Relay 4 energized;
- **Display status:** 3 square red square LED
- **RS485 Communication:** 1 square green LED
 - COM** will flash when the meter is receive or send data, and **COM** flash quickly means the data transient quicker.
- **Max/Mini Hold indication:** 2 square orange LEDs
 - M.H** displayed: When the display function has been selected in Maximum or Minimum Hold function.

■ Stickers:

Each meter has a sticker what are functions and engineer label enclosure.

- **Relay energized mode:** **HH Hi Lo LL DO**
- **Front key functions mode:**
 - PV.H** PV.H(PV Hold) / **Tare** Tare / **DI** DI(Digital Input)
 - M.RS** M.RS(Maximum or Minimum Reset) /
 - R.RS** R.RS(Reset for Relay Latch)
- **Engineer Label:** over 80 types.

- **Operating Key:** 4 keys for Enter(Function) / Shift(Escape) / Up key / Down key

	Setting Status	Function Index
Up key	Increase number	Go back to previous function index
Down key	Decrease number	Go to next function index
Shift key	Shift the setting position	Go back to this function index, and abort the setting
Enter/Fun key	Setting Confirmed and save to EEPROM	From the function index to get into setting status

- **Pass Word:** Settable range:0000~9999;

User has to key in the right pass word so that get into [**Programming Level**] . Otherwise, the meter will go back to measuring page. If user forgets the password, please contact with the service window.

- **Function Lock:** There are 4 levels programmable.

- **None:** no lock all.
- **User Level:** User Level lock. User can get into User Level for checking but setting.
- **Programming Level:** Programming level lock. User can get into programming level for checking but setting.
- **ALL:** All lock. User can get into all level for checking but setting.

■ Down Key Function

- The Key can be set to be the function as below
Relative PV / PV Hold / Reset for maxi(mini) hold / Reset for relay energized latch programmable

OPERATING DIAGRAM (The detail description of operation, please refer to operating manual.)

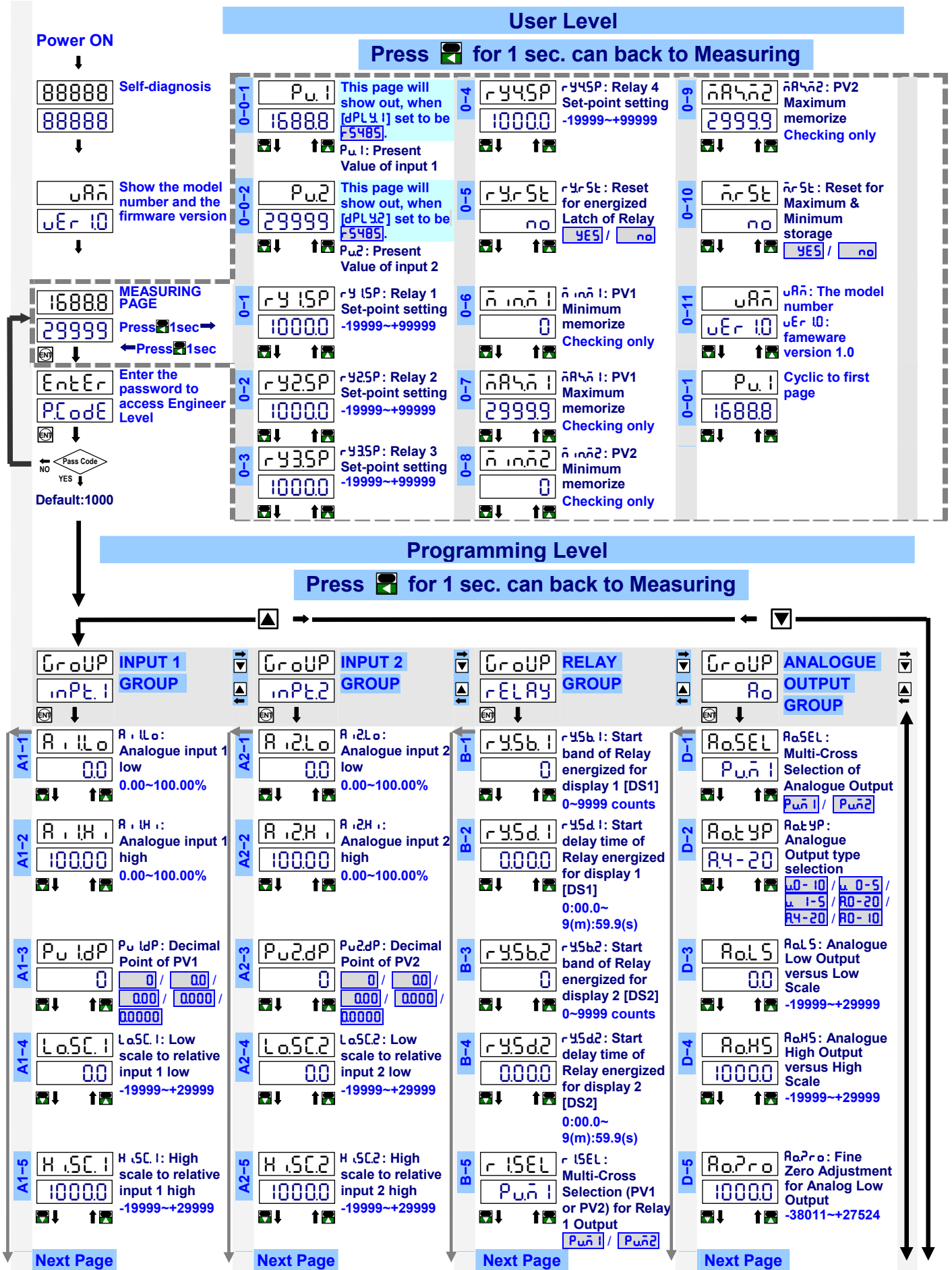

<p>A1-6 Pu1Po: Fine Zero Adjustment for PV display 1 -19999~29999</p>	<p>A2-6 Pu2Po: Fine Zero Adjustment for PV display 2 -19999~29999</p>	<p>B-6 rY1nd: Relay 1 energized mode oFF / Lo / Hi / LaHLd / H.HLd / do</p>	<p>D-6 RaSPn: Fine Span Adjustment for Analog High Output -38011~+27524</p>
<p>A1-7 Pu1Sn: Fine Span Adjustment for PV display 1 -19999~29999</p>	<p>A2-7 Pu2Sn: Fine Span Adjustment for PV display 2 -19999~29999</p>	<p>B-7 rY1HY: Relay 1 Hysteresis 0~5000 counts</p>	<p>D-7 P5CLr: Zero & Span Clear for Adjustment nonE / RaPco / RaSPn / botH</p>
<p>A1-8 P5CL1: Clear Fine Zero & Span Adjustment for PV display 1 nonE / Pu2Po / Pu5Pn / botH</p>	<p>A2-8 P5CL2: Clear Fine Zero & Span Adjustment for PV display 2 nonE / Pu2Po / Pu5Pn / botH</p>	<p>B-8 rY1rd: Relay 1 energized delay time 0:00.0~9(m):59.9(s)</p>	<p>D-8 RaLnt: Analog Output High Limit 0.00~110.00%</p>
<p>A1-9 Pu1f: Mathematic function for PV display 1 [DS1] Pu1 / lAdd2 / lSub2 / lMul2 / lDiv2 / Pu2</p>	<p>A2-9 Pu2f: Mathematic function for PV display 2 [DS2] Pu2 / lAdd2 / lSub2 / lMul2 / lDiv2 / Pu1</p>	<p>B-9 rY1Fd: Relay 1 de-energized delay time 0:00.0~9(m):59.9(s)</p>	
<p>A1-10 dPLY1: Display 1 [DS1] Function Pu1 / nAn1 / nRAn2 / F5485</p>	<p>A2-10 dPLY2: Display 2 [DS2] Function Pu2 / nAn2 / nRAn2 / F5485</p>	<p>B-10 r25EL: Multi-Cross Selection (PV1 or PV2) for Relay 2 Output Pu1 / Pu2</p>	
<p>A1-11 LoCt1: Low Cut level to show "0" for display 1 [DS1] -19999~+29999 counts</p>	<p>A2-11 LoCt2: Low Cut level to show "0" for display 2 [DS2] -19999~+29999 counts</p>	<p>B-11 rY2nd: Relay 2 energized mode oFF / Lo / Hi / LaHLd / H.HLd / do</p>	<p>E-1 AdRES: Device number of the meter 1~255</p>
<p>A1-12 RuG: Average for display 1 [DS1] and display 2 [DS2] smooth 1(no function) ~99 times</p>	<p>A2-12 As same as [input 1 group]</p>	<p>B-12 rY2HY: Relay 2 Hysteresis 0~5000counts</p>	<p>E-2 bRUD: Baud rate 1200 2400 4800 9600 19200 38400</p>
<p>A1-13 nRuG: Moving Average for display 1 [DS1] and display 2 [DS2] smooth 1(no function) ~10 times</p>	<p>A2-13 As same as [input 1 group]</p>	<p>B-13 rY2rd: Relay 2 energized delay time 0:00.0~9(m):59.9(s)</p>	<p>E-3 PrtY: Parity n.Stb.1 n.Stb.2 odd EvEn</p>
<p>A1-14 dFilt: Digital filter for display 1 [DS1] and display 2 [DS2] 0(no function) / 1~99times</p>	<p>A2-14 As same as [input 1 group]</p>	<p>B-14 rY2Fd: Relay 2 de-energized delay time 0:00.0~9(m):59.9(s)</p>	
<p>A1-15 dnKEY: Down key function nonE / nELPu / PuHLd / nRSt / rYrSt</p>	<p>A2-15 As same as [input 1 group]</p>	<p>B-15 r35EL: Multi-Cross Selection (PV1 or PV2) for Relay 3 Output Pu1 / Pu2</p>	
<p>A1-15 PCodE: Pass Code for enter Engineer Level 0000~9999</p>	<p>A2-15 As same as [input 1 group]</p>	<p>B-16 rY3nd: Relay 3 energized mode oFF / Lo / Hi / LaHLd / H.HLd / do / Lo-l2</p>	
<p>A1-15 FLocY: Function Level Lock nonE / USEr / EnG / ALL</p>	<p>A2-15 As same as [input 1 group]</p>	<p>B-17 rY3HY: Relay 3 Hysteresis 0~5000counts</p>	

Next Page

B-18	rY3rd 0000	rY3rd: Relay 3 energized delay time 0:00.0~9(m):59.9(s)
B-19	rY3Fd 0000	rY3Fd: Relay 3 de-energized delay time 0:00.0~9(m):59.9(s)
B-20	rY5EL Pun2	rY5EL: Multi-Cross Selection (PV1 or PV2) for Relay 4 Output Pun1 / Pun2
B-21	rY4nd H	rY4nd: Relay 4 energized mode oFF / Lo / H / oHLd / H.HLd / do / Co-12 / Co-23
B-22	rY4HY 0	rY4HY: Relay 4 Hysteresis 0~5000counts
B-23	rY4rd 0000	rY4rd: Relay 4 energized delay time 0:00.0~9(m):59.9(s)
B-24	rY4Fd 0000	rY4Fd: Relay 4 de-energized delay time 0:00.0~9(m):59.9(s)

▶ Please refer to operating manual for detail description